

Single Loop Controller SDC25/26

■ Features

The DigitroniK SDC25/26 is a digital indicating controller featuring multi-range inputs and PID control system using new algorithms "RationalLOOP" and "Just-FiTTER".

Up to two control output points (this number of points may vary depending on the model) can be used, which are selectable from the relay contact, voltage pulse, and current.

The smart loader package ensures easy setting operation and monitoring.

This controller is compliant to the IEC directives and the CE marking.

- Space saving design with a depth of 65mm.
The mask of the front panel is also only 5mm thick.
- High accuracy of $\pm 0.3\%$ FS and sampling cycle of 0.3s (seconds).
- Multi-range inputs are available for selection, where the input type can be freely changed among thermocouple, RTD, current, and voltage.
- The control method can be selected from any of the ON/OFF control and PID control using "RationalLOOP" + "Just-FiTTER".



- The heat/cool control can be achieved using two control output points and event outputs.
- The PC loader port is provided as a standard function.
- The control output types available for selection are relay, voltage pulse, and current outputs. The heat /cool control can be achieved by interfacing with the 2nd control output in combination with these outputs.
- Event 3 points or 2 points (independent contact), CT input 2 points, DI 4 points, and RS-485 can be selected in combination.
- The smart loader package (SLP-C35) can be used.

■ Basic Function Block of SDC25/26

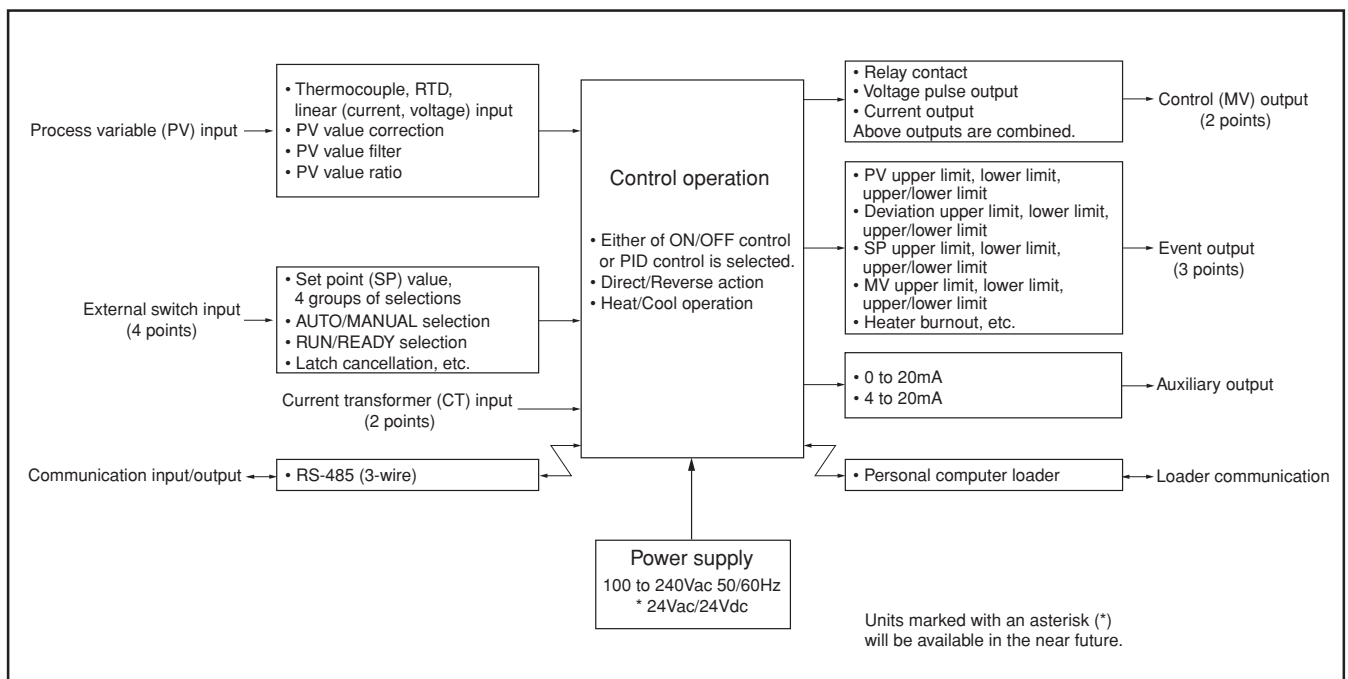

■ Specifications

PV input	Input type	Multi-range of inputs - thermocouple, RTD, DC current and DC voltage			
	Input sampling time	0.3s			
	Input bias current	Thermocouple input: 0.2μA or less RTD input: 1mA typical DC voltage input: 1V range or less... 1μA or less 0 to 5V, 1 to 5V range... 3.5μA or less 0 to 10V range... 7μA or less	(Note 1) RTD or A-wire burnout: Upscale + AL01 B-wire or C-wire burnout: Upscale + AL01, 03 More than 2-wire burnout: Upscale + AL01		
	Burnout	Thermocouple input: Upscale + alarm display RTD input: Upscale + alarm display (Note 1) DC voltage input: Upscale + alarm display (However, the burnout cannot be detected for the 0 to 10V range.) DC current input: Upscale + alarm display (However, the burnout cannot be detected for the 0 to 20mA range.)			
Indications and setting	PV, SP indication method	4-digit, 7-segment LED (PV: Upper green display, SP: Lower orange display)			
	Number of setting points	Max. 4 points			
	Setting range	Lower to higher limit value of the PV range (SP upper/lower limit available)			
	Multi-status indicator	The control output status, alarm or RUN/READY status is indicated.			
	Indication accuracy	±0.3%FS±1 digit In the negative area of the thermocouple, the accuracy is ±0.6%FS±1 digit (at an ambient temperature of 23±2°C.)			
	Indication range	See Table 1.			
Control output	Output type	Relay contact	Voltage pulse	Current	
	Control action	Time proportional PID	Time proportional PID	Continuous PID	
	Number of PID groups	Max. 4 groups	Max. 4 groups	Max. 4 groups	
	PID auto-tuning	Automatic PID value setting by limit cycle method. However, one of the following 3 control characteristics can be selected: • Standard • Quick disturbance response • Less up/down fluctuations			
	Output rating	NO side: 250Vac/30Vdc, 3A (resistive load) NC side: 250Vac/30Vdc, 1A (resistive load) Service life: NO side: 50,000 cycles or more NC side: 100,000 cycles or more Min. opening/closing time: 250ms	Open terminal voltage: 19Vdc±15% Internal resistance: 82Ω±0.5% Allowable current: Max. 24mAdc Min. OFF/ON time: When 1s or less: 1ms When 2 to 9s: Cycle time x 1ms When 10s or longer: 250ms	Output type: 0 to 20mAdc or 4 to 20mAdc Allowable load resistance: Max. 600Ω Output accuracy: ±0.3%FS (However, ±1%FS for 0 to 1mA)	
	Cycle time (s)	5 to 120	0.1, 0.25, 0.5, 1 to 20	—	
	PID control	Proportional band (%FS)	0.1 to 999.9		
		Integral time (s)	0 to 9999		
		Derivative time (s)	0 to 9999		
		Manual set (%)	-10.0 to +110.0		
	Just-FITTER	Overshoot suppression coefficient	0 to 100		
	ON/OFF control	Operating differential (°C)	0 to 9999 digit		
	Control operation selection	Direct action or reverse action (However, reverse action only for heat/cool control)			
	Heat/Cool control selection	Control output and event output, auxiliary output			
Auxiliary output	Output type	0 to 20mAdc or 4 to 20mA			
	Load resistance	Max. 600Ω			
	Output accuracy	±0.3%FS (However, ±1 digit for 0 to 1mA)			
External contact input (DI)	Number of inputs	Max. 4 points			
	Function	Up to 4 kinds of setting value (SP) selections, PID group selection, RUN/READY selection, AUTO/MANUAL selection, Auto tuning stop/start, Control action Direct/Reverse selection, SP ramp enable/disable, PV value hold, Max. PV value hold, Min. PV value hold, Timer start/stop, All DO latch cancellation			
	Input rating	Non-voltage contact or open collector			
	Min. detection holding time	0.6s or longer			
	Allowable ON contact resistance	Max. 250Ω			
	Allowable OFF contact resistance	Min. 100kΩ			
	Allowable ON-state residual voltage	Max. 1.0V			
	Open terminal voltage	5.5Vdc±1V			
ON terminal current	Approx. 7.5mA (at short-circuit), Approx. 5.0mA (at contact resistance of 250Ω)				

Event	Number of output points	2 to 3 points (according to a model)			
	Number of internal event settings	Up to 8 settings			
Event type <ul style="list-style-type: none"> ● shows that the ON/OFF is changed at this value. ○ shows that the ON/OFF is changed at a point that "1U" is added to this value. 	PV high limit		PV low limit		
	Direct action	Reverse action	Direct action	Reverse action	
	PV high/low limit		Deviation high limit		
	Direct action	Reverse action	Direct action	Reverse action	
	Deviation low limit		Deviation high/low limit		
	Direct action	Reverse action	Direct action	Reverse action	
	SP high limit		SP low limit		
	Direct action	Reverse action	Direct action	Reverse action	
	SP high/low limit		MV high limit		
	Direct action	Reverse action	Direct action	Reverse action	
	MV low limit		MV high/low limit		
	Direct action	Reverse action	Direct action	Reverse action	
	Heater burnout/Over-current		Heater short-circuit		
	Direct action	Reverse action	Direct action	Reverse action	

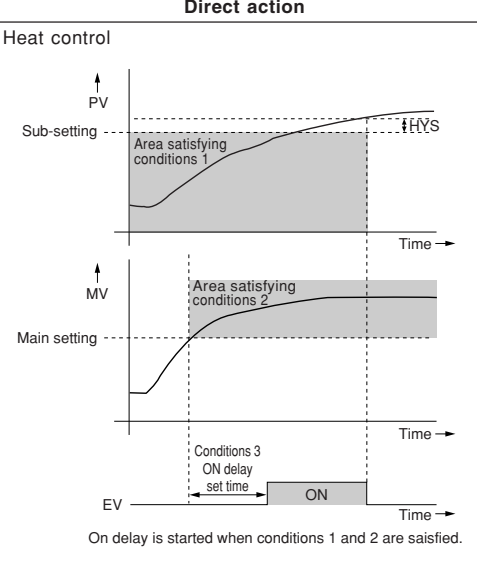
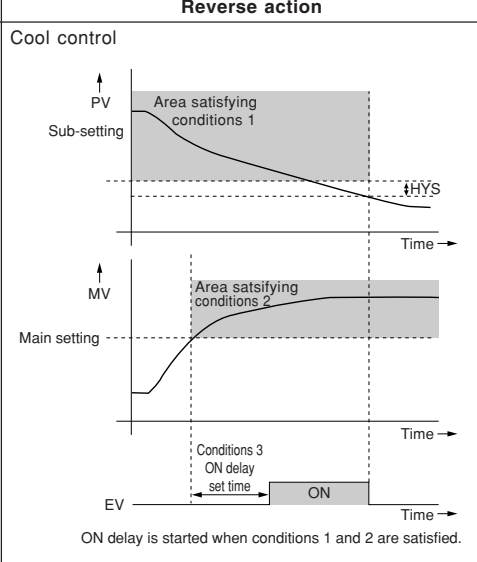
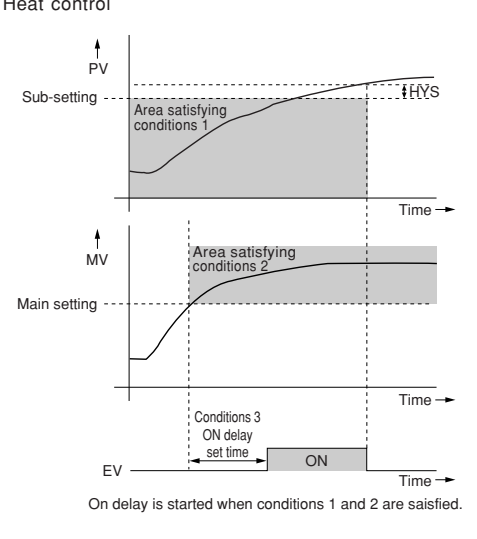
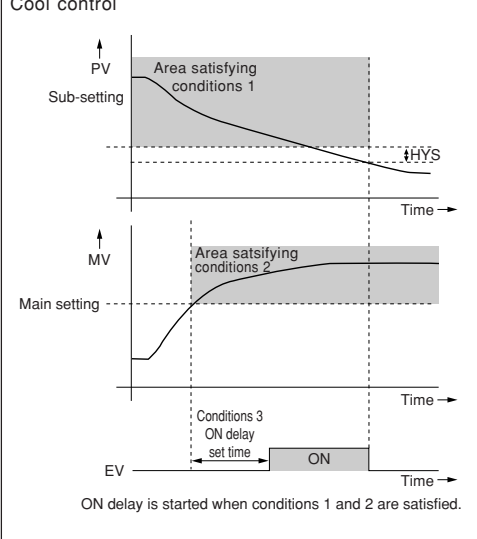
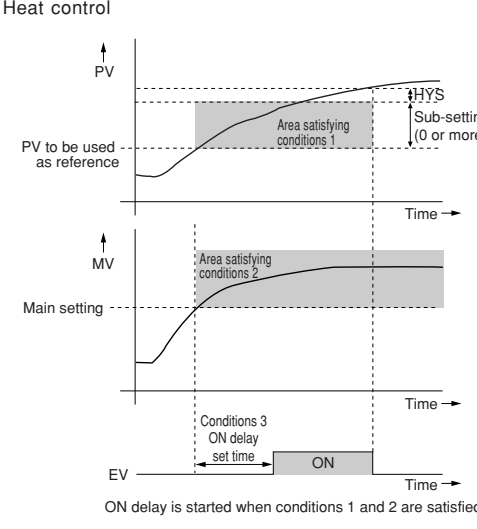
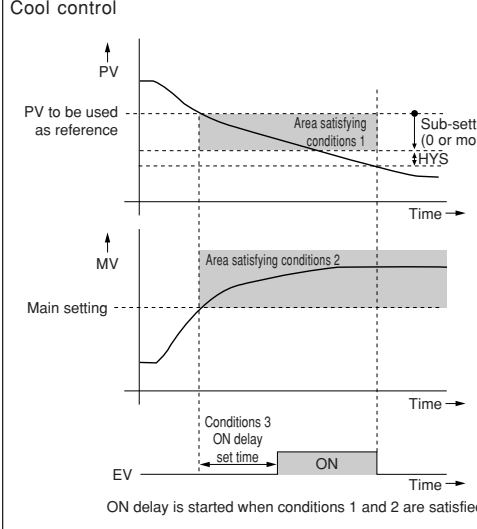
Event Event type <ul style="list-style-type: none"> ● shows that the ON/OFF is changed at this value. ○ shows that the ON/OFF is changed at a point that "1U" is added to this value. 	<p>The event is turned ON when any change in PV corresponding to increase/decrease in MV (Manipulated variable) is not observed.</p> <p>This event is used to detect any fault of final control devices.</p> <ul style="list-style-type: none"> ● Setting items <ul style="list-style-type: none"> • Main setting: MV (Manipulated variable) • Sub-setting: PV • ON delay time: Diagnosis time ● Operation specifications <p>The event is turned ON when the value does not reach the PV set in the sub-setting within the diagnosis time (ON delay time) even though the MV exceeding the main setting is held.</p> ● CAUTION <p>When setting the ON delay, it is necessary to put in "Multi-function setup". The default setting of the ON delay before shipment is 0.0s.</p> 	Loop diagnosis 1	
		<p>Direct action</p> <p>Heat control</p>  <p>On delay is started when conditions 1 and 2 are satisfied.</p>	<p>Reverse action</p> <p>Cool control</p>  <p>ON delay is started when conditions 1 and 2 are satisfied.</p>
		Loop diagnosis 2	
		<p>Direct action</p> <p>Heat control</p>  <p>ON delay is started when conditions 1 and 2 are satisfied.</p>	<p>Reverse action</p> <p>Cool control</p>  <p>ON delay is started when conditions 1 and 2 are satisfied.</p>
	<p>The event is turned ON when any change in PV corresponding to increase/decrease in MV (Manipulated variable) is not observed.</p> <p>This event is used to detect any fault of final control devices.</p> <ul style="list-style-type: none"> ● Setting items <ul style="list-style-type: none"> • Main setting: MV (Manipulated variable) • Sub-setting: Change in PV from the point that the MV exceeds the main setting. • ON delay time: Diagnosis time ● Operation specifications <p>The event is turned ON when the MV exceeding the main setting is held (conditions 2) and the PV does not reach the value that the sub-setting is added to (subtracted from) the PV at the point where the MV exceeds the main setting within the diagnosis time (ON delay time) (conditions 1).</p> ● CAUTION <p>When setting the ON delay, it is necessary to put in "Multi-function setup". The default setting of the ON delay before shipment is 0.0s.</p> 	Loop diagnosis 2	
	<p>Direct action</p> <p>Heat control</p>  <p>ON delay is started when conditions 1 and 2 are satisfied.</p>	<p>Reverse action</p> <p>Cool control</p>  <p>ON delay is started when conditions 1 and 2 are satisfied.</p>	

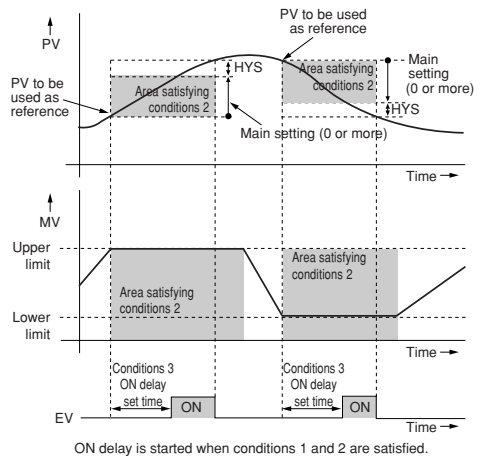
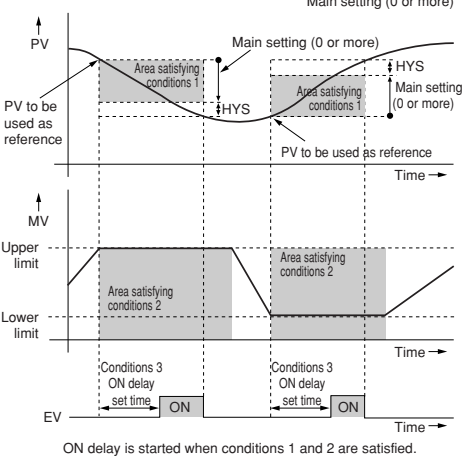
Event	Event type	Loop diagnosis 3	
	<ul style="list-style-type: none"> ● shows that the ON/OFF is changed at this value. ○ shows that the ON/OFF is changed at a point that "1U" is added to this value. 	<p>The event is turned ON when any change in PV corresponding to increase/decrease in MV (Manipulated variable) is not observed. This event is used to detect any fault of final control devices.</p> <ul style="list-style-type: none"> ● Setting items <ul style="list-style-type: none"> • Main setting: Change in PV from the point that the MV reaches the upper limit (100%) or lower limit (0%). • Sub-setting: Range of absolute value of deviation (PV – SP) allowing the event to turn OFF. • ON delay time: Diagnosis time • OFF delay time: A period of time from power ON allowing the event to turn OFF. ● Operation specifications <ul style="list-style-type: none"> • The direct action is used for the heat control. The event is turned ON when the increase in PV becomes smaller than the main setting after the diagnosis time (ON delay time) has elapsed from the time that the MV had reached the upper limit, or when the decrease in PV becomes smaller than the main setting from the time that the diagnosis time (ON delay time) has elapsed from the time that the MV had reached the lower limit. • The reverse action is used for the cool control. The event is turned ON when the decrease in PV becomes smaller than the main setting after the diagnosis time (ON delay time) has elapsed from the time that the MV had reached the upper limit, or when the increase in PV becomes smaller than the main setting after the diagnosis time (ON delay time) has elapsed from the time that the MV had reached the lower limit. • The event is turned OFF regardless of other conditions when the absolute value of the deviation (PV – SP) becomes less than the sub-setting. • The event is turned OFF regardless of other conditions when a period of time after starting of operation from the time that the power has been turned ON becomes less than the OFF delay time. However, the event is turned OFF when the absolute value of the deviation is the (sub-setting – hysteresis) value or less after the absolute value of the deviation has become the sub-setting or more. ● CAUTION <ul style="list-style-type: none"> When setting the ON delay and OFF delay, it is necessary to put in "Multi-function setup". The default settings of the ON delay and OFF delay before shipment are 0.0s. 	
		<p style="text-align: center;">Direct action</p> <p>Heat control</p> 	<p style="text-align: center;">Reverse action</p> <p>Cool control</p> 
		PV alarm (status)	
		Direct action	Reverse action
		ON if PV alarm (alarm code AL01 to 99) occurs, OFF in other cases.	OFF if PV alarm (alarm code AL01 to 03) occurs, ON in other cases.
		READY (status)	
		Direct action	Reverse action
		ON in the READY mode. OFF in the RUN mode.	OFF in the READY mode. ON in the RUN mode.
		MANUAL (status)	
		Direct action	Reverse action
		ON in the MANUAL mode. OFF in the AUTO mode.	OFF in the MANUAL mode. ON in RUN mode.
		During AT (Auto tuning)	
		Direct action	Reverse action
		ON while AT is running. OFF while AT is being stopped.	OFF while AT is running. ON while AT is being stopped.
		During SP ramp	
		Direct action	Reverse action
		ON during SP ramp. OFF when SP ramp is not performed or is completed.	OFF during SP ramp. ON when SP ramp is not performed or is completed.
		Control operation (status)	
		Direct action	Reverse action
		ON during direct action (cooling). OFF during reverse action (heating).	OFF during direct action (cooling). ON during reverse action (heating).
		ST (Smart Tuning) setting standby (status)	
		Direct action	Reverse action
		ON in the ST setting standby. OFF in the ST setting completion.	OFF in the ST setting standby. ON in the ST setting completion.

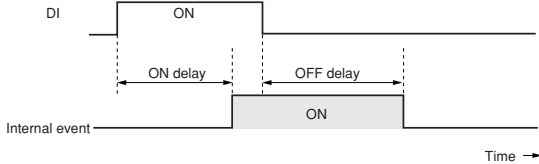
Event	Event type	Timer (status)		
	<ul style="list-style-type: none"> ● shows that the ON/OFF is changed at this value. ○ shows that the ON/OFF is changed at a point that "1U" is added to this value. 	<p>The direct and reverse action settings are disabled for the timer event. When using the timer event, it is necessary to set the operation type of the DI allocation to "Timer Start/Stop". Additionally, when setting the event channel designation of the DI allocation, multiple timer events are controlled from individual internal contacts (DI).</p> <ul style="list-style-type: none"> ● Setting items <ul style="list-style-type: none"> • ON delay time: A period of time necessary to change the event from OFF to ON after DI has been changed from OFF to ON. • OFF delay time: A period of time necessary to change the event from ON to OFF after DI has been changed from ON to OFF. ● Operation specifications <ul style="list-style-type: none"> • The event is turned ON when DI ON continues for ON delay time or longer. • The event is turned OFF when DI OFF continues for OFF delay time or longer. • In other cases, the current status is continued. <div style="text-align: center; margin: 10px 0;">  </div> <ul style="list-style-type: none"> ● CAUTION <p>When setting the ON delay and OFF delay, it is necessary to put in "Multi-function setup". The default settings of the ON delay and OFF delay before shipment are 0.0s. The default setting of the event channel designation of the DI allocation before shipment is "0". In this case, the timer event start/stop can be set for all internal events from one internal contact (DI). Additionally, as one or more event channel designation is set, the timer event start/stop can be set for one internal event specified by one internal contact (DI). However, when setting the event channel of the DI allocation, it is necessary to put in "Multi-function setup".</p> 		
	Operating differential	0 to 9999 digit		
	Output operation	ON/OFF operation		
	Output type	SPST relay contacts, Common for 3 points/independent contact for 2 points		
	Output rating	250Vac/30Vdc, 2A (resistive load)		
	Life	100,000 cycles or more		
	Min. opening and closing specifications	5V, 10mA (reference value)		
Communication	Communication system	Communication protocol	RS-485	
		Network	Multidrop, This device is provided with the slave station function. 1 to 31 units max.	
		Data flow	Half-duplex	
		Synchronization method	Start/stop synchronization	
	Interface	Transmission system	Balance (differential) type	
		Data line	Bit serial	
		Communication lines	3 transmit/receive lines	
		Transmission speed	4800, 9600, 19200, 38400 bps	
		Communication distance	500m max.	
		Protocol	RS-485 (3-wire type)	
	Message characters	Character configuration	9 to 12 bits/character	
		Data length	7 or 8 bits	
		Stop bit length	1 or 2 bits	
		Parity bit	Even parity, odd parity, or non-parity	
Loader communication	Communication line	3-wire		
	Transmission speed	Fixed at 19200 bps		
	Recommended cable	Dedicated cable, 2 m long		
Current transformer input	Number of inputs	2 points		
	Detection function	Control output is ON.: Detection of heater line break or overcurrent Control output is OFF.: Detection of final control devices short-circuit		
	Input object	Number of current transformer windings: 800 turns QN206A (5.8mm-hole diameter) Optional QN212A (12mm-hole diameter) Optional		
	Measurement current range	0.4 to 50A		
	Indication accuracy	±5%FS±1 digit		
	Indication range	0.0 to 70.0A		
	Indication resolution	0.1A		
	Output	Selected from control output 1 and control output 2, or event output 1, event output 2, and event output 3.		
	Min. detection time	Burnout detection: Min. control output ON time 0.3s or more Final control device short-circuit detection: Min. control output OFF time 0.3s or more		

General specifications	Memory backup	Semiconductor non-volatile memory					
	Power supply voltage	AC power supply model: 85 to 264Vac, 50/60Hz±2Hz					
	Power consumption	AC power supply model: Max. 12VA					
	Insulation resistance	Between power supply terminal and secondary terminal, 500Vdc, 10MΩ or more					
	Dielectric strength	AC power supply model: Between power supply terminal and secondary terminal, 1500Vac for 1 min.					
	Power ON inrush current	AC power supply model: 20A or less					
	Operating conditions	Ambient temperature	0 to 50°C (0 to 40°C for side-by-side mounting)				
		Ambient humidity	10 to 90%RH (No condensation allowed)				
		Vibration resistance	0 to 2m/s ² (10 to 60Hz for 2 hrs. in each of X, Y, and Z directions)				
		Shock resistance	0 to 10m/s ²				
		Mounting angle	Reference plane ±10°				
	Transportation conditions	Ambient temperature	-20 to +70°C				
		Ambient humidity	10 to 95%RH (No condensation allowed)				
		Package drop test	Drop height, 60cm, (1 corner, 3 sides, 6 planes, free fall)				
	Console and case material	Console: Polycarbonate Case: Modified PPE					
	Case color	Light gray (DIC650)					
Conformed standards	EN61010-1, EN61326-1						
Overvoltage category	Category II (IEC60364-4-433, IEC644-1)						
Mounting	Panel mounting (with dedicated mounting bracket)						
Weight	SDC25: Approx. 250g (including dedicated mounting bracket) SDC26: Approx. 300g (including dedicated mounting bracket)						
Standard accessories	Part name	Model	Q'ty	Optional parts (sold separately)	Part name	Model	Q'ty
	Mounting bracket	81409654-001	1		Mounting bracket	81409654-001	1
	User's manual	CP-UM-5288E	1		Current transformer	QN206A (5.8mm-hole dia.)	1
						QN216A (12mm-hole dia.)	1
					Hard cover	81446915-001 (for SDC25)	1
						81446916-001 (for SDC26)	1
					Terminal cover	81446912-001 (for SDC25)	1
						81446913-001 (for SDC26)	1
					Smart loader package	SLP-C35J50 (common for SDC25 and SDC26)	1

Table 1 Input Types and Ranges

Input type	C01 No.	Sensor type	Range	
Thermo-couple	1	K	-200 to +1200°C	-300 to +2200°F
	2	K	0 to 1200°C	0 to 2200°F
	3	K	0 to 800°C	0 to 1500°F
	4	K	0.0 to 600.0°C	0 to 1100°F
	5	K	0.0 to 400.0°C	0 to 700°F
	6	K	-200.0 to +400.0°C	-300 to +700°F
	7	K	-200.0 to +200.0°C	-300 to +400°F
	8	J	0 to 1200°C	0 to 2200°F
	9	J	0.0 to 800.0°C	0 to 1500°F
	10	J	0.0 to 600.0°C	0 to 1100°F
	11	J	-200.0 to +400.0°C	-300 to +700°F
	12	E	0.0 to 800.0°C	0 to 1500°F
	13	E	0.0 to 600.0°C	0 to 1100°F
	14	T	-200.0 to +400.0°C	-300 to +700°F
	15	R	0 to 1600°C	0 to 3000°F
	16	S	0 to 1600°C	0 to 3000°F
	17	B	0 to 1800°C	0 to 3300°F
	18	N	0 to 1300°C	0 to 2300°F
	19	PL II	0 to 1300°C	0 to 2300°F
	20	Wre5-26	0 to 1400°C	0 to 2400°F
	21	Wre5-26	0 to 2300°C	0 to 4200°F
	22	Ni-NiMo	0 to 1300°C	0 to 2300°F
	23	PR40-20	0 to 1900°C	0 to 3400°F
	24	DIN U	-200.0 to +400.0°C	-300 to +700°F
	25	DIN L	-100.0 to +800.0°C	-150 to +1500°F
	26	Golden iron chromel	0.0K to 360.0°K	0.0 to 360.0°K

Input type	C01 No.	Sensor type	Range	
RTD	41	Pt100	-200.0 to +500.0°C	-300 to +900°F
	42	JPt100	-200.0 to +500.0°C	-300 to +900°F
	43	Pt100	-200.0 to +200.0°C	-300 to +400°F
	44	JPt100	-200.0 to +200.0°C	-300 to +400°F
	45	Pt100	-100.0 to +300.0°C	-150 to +500°F
	46	JPt100	-100.0 to +300.0°C	-150 to +500°F
	47	Pt100	-100.0 to +200.0°C	-150 to +400°F
	48	JPt100	-100.0 to +200.0°C	-150 to +400°F
	49	Pt100	-100.0 to +150.0°C	-150 to +300°F
	50	JPt100	-100.0 to +150.0°C	-150 to +300°F
	51	Pt100	-50.0 to +200.0°C	-50 to +400°F
	52	JPt100	-50.0 to +200.0°C	-50 to +400°F
	53	Pt100	-50.0 to +100.0°C	-50 to +200°F
	54	JPt100	-50.0 to +100.0°C	-50 to +200°F
	55	Pt100	-60.0 to +40.0°C	-60 to +100°F
	56	JPt100	-60.0 to +40.0°C	-60 to +100°F
	57	Pt100	-40.0 to +60.0°C	-40 to +140°F
	58	JPt100	-40.0 to +60.0°C	-40 to +140°F
	59	Pt100	-10.00 to +60.00°C	-10 to +140°F
	60	JPt100	-10.00 to +60.00°C	-10 to +140°F
	61	Pt100	0.0 to 100.0°C	0 to 200°F
	62	JPt100	0.0 to 100.0°C	0 to 200°F
	63	Pt100	0.0 to 200.0°C	0 to 400°F
	64	JPt100	0.0 to 200.0°C	0 to 400°F
	65	Pt100	0.0 to 300.0°C	0 to 500°F
	66	JPt100	0.0 to 300.0°C	0 to 500°F
	67	Pt100	0.0 to 500.0°C	0 to 900°F
	68	JPt100	0.0 to 500.0°C	0 to 900°F

! Handling Precautions

- The accuracy is $\pm 0.3\%FS \pm 1$ digit, and $\pm 0.6\%FS \pm 1$ digit for a negative area of the thermocouple.
- The accuracy varies according to the range.
The accuracy of the No.17 (sensor type B) is $\pm 4.0\%FS$ for a range of 260°C or less, $\pm 0.4\%FS$ for 260 to 800°C.
The accuracy of the No.23 (sensor type PR40-20) is $\pm 2.5\%FS$ for 0 to of 300°C, and $\pm 1.5\%FS$ for 300 to 800°C, $\pm 0.5\%FS$ for 800 to of 1900°C.
The accuracy of the No.26 (sensor type golden iron chromel) is $\pm 1.5K$.
- For ranges with a decimal point, tenths are displayed on the line underneath point.

Input type	C01 No.	Sensor type	Range
Linear input	81	0 to 10mV	Scaling in the range of -1999 to +9999 Decimal point position changeable
	82	10 to +10mV	
	83	0 to 100mV	
	84	0 to 1V	
	86	1 to 5V	
	87	0 to 5V	
	88	0 to 10V	
	89	0 to 20mA	
	90	4 to 20mA	

■ Model Selection Guide

I II III IV V VI VII VIII Example: C25TR0UA1000

I	II	III	IV	V	VI	VII	VIII	Specifications	
Basic model No.	Mounting	Control output	PV input	Power supply	Option 1	Option 2	Additional processing		
C25								Mask size 48mm x 96m	
C26								Mask size 96mm x 96mm	
	T							Panel mounting type	
								Control output 1	Control output 2
		R0						Relay contact output	—
		V0						Voltage pulse output (for SSR drive)	—
		VC						Voltage pulse output (for SSR drive)	Current output
		VV						Voltage pulse output (for SSR drive)	Voltage pulse output (for SSR drive)
		C0						Current output	—
		CC						Current output	Current output
			U					Universal	
				A				AC model (100 to 240Vac) 50/60Hz	
				D				DC model (24Vac/dc) (available soon)	
					1			Event relay output: 3 points	
					2			Event relay output: 3 points, Auxiliary output (current output)	
				(Note 1)	4			Event relay output: 2 points (independent contact),	
				(Note 1)	5			Event relay output: 2 points (independent contact), Auxiliary output (current output)	
					0			—	
				(Note 2)	1			Current transformer inputs: 2 points, Digital inputs: 4 points	
				(Note 2)	2			Current transformer inputs: 2 points, Digital inputs: 4 points, RS-485 Communication	
						00		No additional processing	
						D0		Inspection Certificate provided	
						Y0		Complying with the traceability certification	

Note 1. Can not be selected for DC model.

Note 2. Current transformer is sold separately.

■ Dimensions

● C25

(Unit: mm)

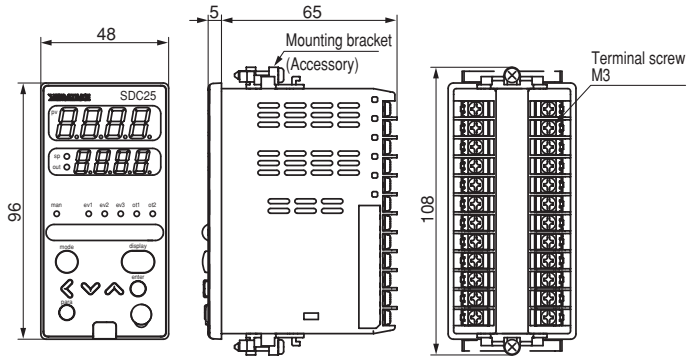

● C26

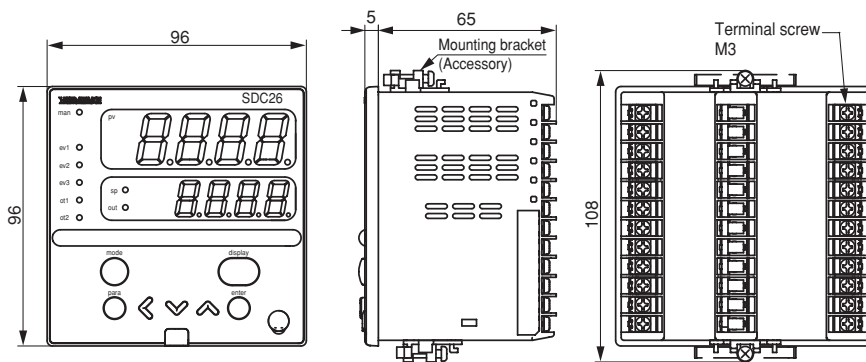

! Handling Precautions

To fasten this controller onto the panel, tighten a mounting bracket screws, and turn one more half turn when there is no play between the bracket and panel. Excessively tightening the screws may deform the controller case.

● Panel cutout diagram

● C25

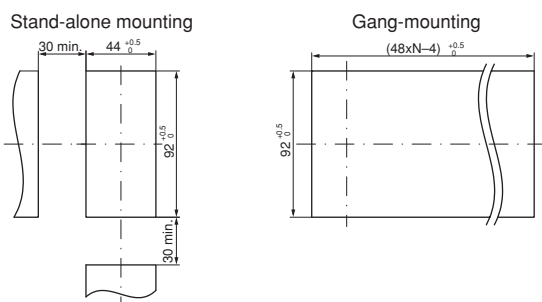

● C26

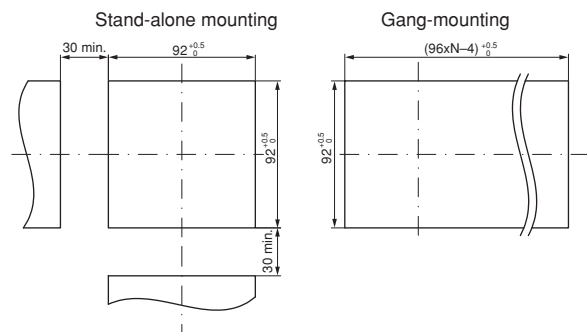

! Handling Precautions

- When three or more units are gang-mounted horizontally, the maximum allowable ambient temperature is 40°C.
- For water-proof installation, install the attached gasket and then mount the device as a stand-alone device.

Part Names and Functions

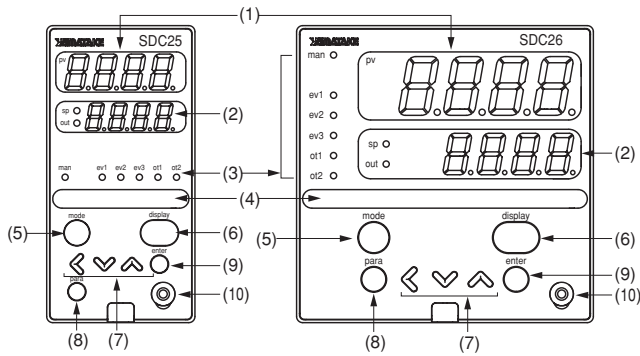

- (1) Upper display: Displays PV values (present temperature, etc.) or setup items.
- (2) Lower display: Displays SP values (set temperature, etc.) and other parameter values. When the lower display shows the SP value, the "sp" lamp lights up. When the display shows the manipulated variable (MV), the "out" lamp lights up.

- (3) Mode indicator
 man: Lights when MANUAL (manual mode).
 ev1 to ev3: Lights when event relays are ON.
 ot1, ot2: Lights when the control output is ON.
- (4) Multi-status indicator:
 In the combination of the lighting condition and the lighting status as a group, the priority 3 groups can be set.
- (5) [mode] key: The operation which has been set beforehand can be done by pushing the key for 1s or more.
- (6) [display] key: Used to change the display contents in the operation display mode. Display is returned from bank setup display to operation display.
- (7) < , v , ^ key: Used for incrementing numeric values and performing arithmetic shift operations.
- (8) [para] key: Switches the display.
- (9) [enter] keys: Used to set the setup values at the start of change and during the change.
- (10) Loader connector: Connects to a personal computer by using a dedicated cable supplied with the Smart Loader Package.

Connection of C25/26

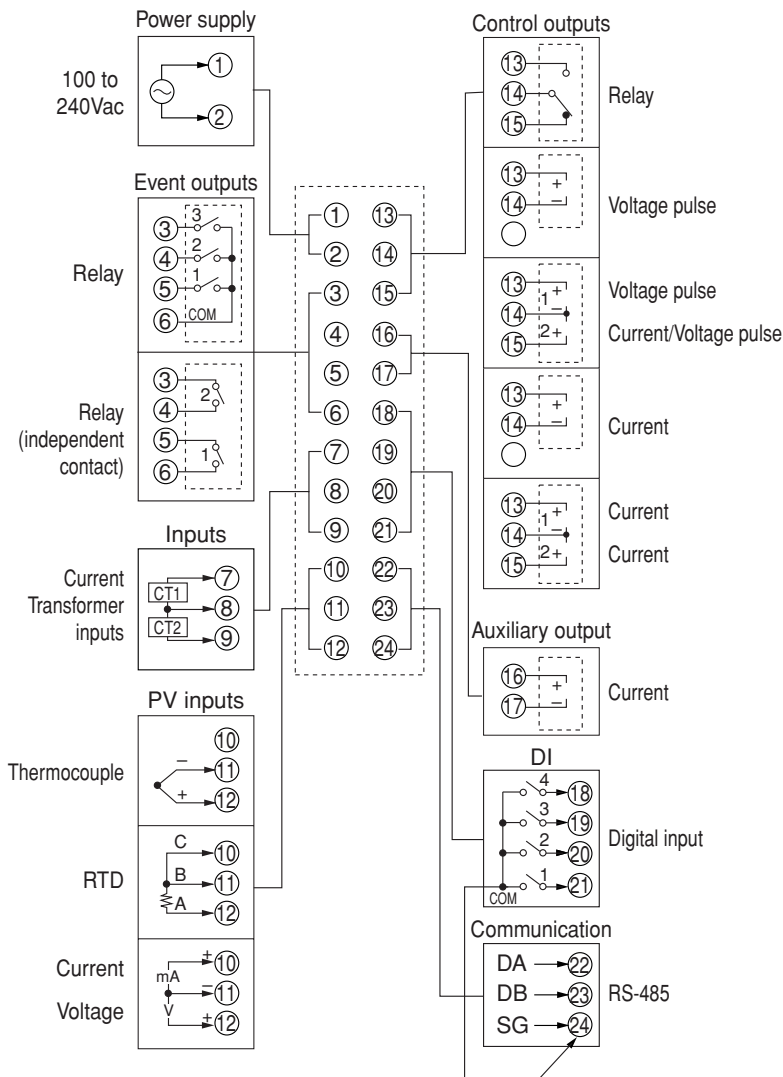

● **Precautions on the use of self-tuning function**

The final control devices must be powered up simultaneously with or prior to the instrument when the self-tuning function is to be used.

● **Precautions on wiring**

1. Isolation within instrument

Solid line portions " — " are isolated.
Dotted line portions " - - - " are not isolated.

Power supply	Internal Circuit	Control output 1
PV input		Control output 2
Current Transformer input 1		Auxiliary output
Current Transformer input 2		
Loader communication		Event output 1 (Note 1) Event output 2 (Note 1) Event output 3
Digital input 1		
Digital input 2		
Digital input 3		
Digital input 4		
RS-485 Communication		

Availability of input and output is based on a model number.
Note 1 In case of independent contact, the part between the event output 1 and the event output 2 is isolated.

2. Preventive measures against noise of instrument power supply

- (1) Reduction of noise
Even though the noise is small, the noise filter is used to eliminate the effect of the noise as much as possible.

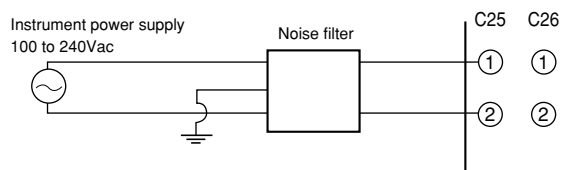

- (2) When noise is excessive
If a large amount of noise exists, appropriate isolation transformer and line filter are used to eliminate the effect of the noise.

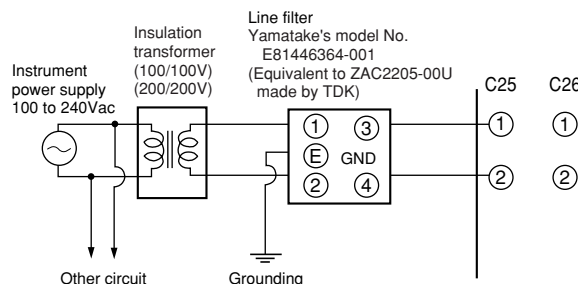

3. Installation environment noise sources and preventive measures

Generally, the following may be the noise sources in the installation environment:
Relay and contact, electromagnetic coil, solenoid valve, power supply line (particularly, 100Vac or more), motor commutator, phase angle control SCR, radio communication device, welding machine, high-voltage ignitor, etc.

Preventive measures against fast rise noise

Use of CR filter is effective to prevent fast rise noise.
Recommended filter:
Yamatake's model No. **81446365-001**
(Equivalent to 953M500333311 made by Matsuo Electric.)

4. Wiring precautions

- (1) After taking the noise preventive measures, do not bundle the primary and secondary power cables together or put both power cables in the same conduit or duct.
- (2) Keep the input/output and communication lines 50 cm or more away from the power lines and power supply lines having a voltage of 100Vac or more.
Additionally, do not put these lines together in the same conduit or duct.

5. Inspection after wiring

After the wiring work has been completed, always inspect and check the wiring status. Great care should be taken since incorrect wiring may cause the instrument to malfunction or severe personal injury.

⚠ RESTRICTIONS ON USE

This product has been designed, developed and manufactured for general-purpose application in machinery and equipment. Accordingly, when used in the applications outlined below, special care should be taken to implement a fail-safe and/or redundant design concept as well as a periodic maintenance program.

- Safety devices for plant worker protection
- Start/stop control devices for transportation and material handling machines
- Aeronautical/aerospace machines
- Control devices for nuclear reactors

Never use this product in applications where human safety may be put at risk.

Specifications are subject to change without notice.

**Yamatake Corporation
Advanced Automation Company**

1-12-2 Kawana, Fujisawa
Kanagawa 251-8522 Japan
URL: <http://www.azbil.com>



Printed in Japan. (H)
1st Edition: Issued in Jan., 2004